

STROKE ASSESSMENT AND PREVENTION POCKET CARDS



HEART &
STROKE
FOUNDATION

CANADIAN
Stroke
BEST PRACTICE
RECOMMENDATIONS

STROKE ASSESSMENT AND PREVENTION POCKET CARDS



HEART &
STROKE
FOUNDATION

CANADIAN
Stroke
BEST PRACTICE
RECOMMENDATIONS

TABLE OF CONTENTS

i. Common Signs and Symptoms of Stroke Syndromes.....	1
ii. Common Symptoms in Stroke Patients.....	2
iii. Glossary of Frequently used Terms in Stroke.....	3
iv. Cranial Nerve Function and Testing.....	4
v. Types of Stroke.....	5
vi. Functions of the Brain and Their Relation to Stroke.....	7
vii. Canadian Neurological Scale.....	11
viii. NIH Stroke Scale.....	13
ix. Recurrent Stroke Risk Assessment and Prevention Guide	23
x. FAST – Signs of Stroke.....	31

COMMON SIGNS AND SYMPTOMS OF STROKE SYNDROMES

Anterior Cerebral Stroke	Middle Cerebral Stroke	Posterior Cerebral Stroke	Vertebro Basilar Stroke	Thalamic Stroke	Lacunar Stroke Four Types
<ul style="list-style-type: none"> • Contralateral sensorimotor deficit: foot and leg • Arm paresis • Gait ataxia • Bladder incontinence • Personality and behaviour changes • Flat affect, distractible • Perservation and amnesia 	<ul style="list-style-type: none"> • Contralateral sensorimotor deficit: face, arm, leg • Contralateral homonymous hemianopsia • Contralateral hemi-spatial neglect or inattention (usually in Right Hemispheric Strokes) • Aphasia, alexia, agraphia (usually in Left Hemispheric Stroke or dominant hemisphere) • Gaze deviation towards affected hemisphere • Dysarthria 	<ul style="list-style-type: none"> • Pure homonymous hemianopsia • Nausea • Vomiting • Ataxia • Vertigo • Weakness • Sensory loss • Dysarthria 	<ul style="list-style-type: none"> • Vertigo • Limb and gait ataxia • Cranial nerve dysfunction • Coma at onset • Diplopia • Cross sensory loss • Bilateral motor deficits • Isolated field defect • Pure motor/sensory loss • Dysarthria • Dysphagia 	<ul style="list-style-type: none"> • Alteration in senses (except smell) • Alteration in pain, crude touch (loss) • Alteration in temperature • Contralateral hemiplegia • Hyper-sensitivity to stimulus • Vertical and lateral gaze deficits • Short-term memory loss 	<p><i>Pure motor hemiparesis</i></p> <ul style="list-style-type: none"> • Contralateral hemiparesis of face, arm and leg <p><i>Ataxic Hemiparesis</i></p> <ul style="list-style-type: none"> • Ipsilateral paresis of leg • Arm and leg ataxia <p><i>Dysarthria and Clumsy Hand Syndrome</i></p> <ul style="list-style-type: none"> • Dysarthria • Weakness of hand • Impaired manual dexterity <p><i>Pure Sensory Stroke</i></p> <ul style="list-style-type: none"> • Impairments in pain, temperature, touch, position and vibration

COMMON SYMPTOMS IN STROKE PATIENTS

The effects of a stroke depend on several factors including the location of the obstruction and how much brain tissue is affected. However, because one side of the brain controls the opposite side of the body, a stroke affecting one side will result in neurological complications on the opposite side.

Right Hemispheric Stroke

If the stroke occurs in the brain's right side, the left side of the body will be affected, which could produce any or all of the following:

- Contralateral face, arm and leg weakness or hemiparesis
- Contralateral arm and/or leg sensory loss or extinction
- Hemispatial neglect or inattention
- Deficit and/or neglect of left visual field
- Right gaze preference
- Impulsive or overestimation of abilities (risk for injury)

Left Hemispheric Stroke

If the stroke occurs in the left side of the brain, the right side of the body will be affected, producing some or all of the following:

- Contralateral face, arm and leg weakness or hemiparesis
- Contralateral face, arm and/or leg sensory loss
- Aphasia, alexia, agraphia
- Slow and cautious behaviour
- Deficits in right visual field
- Left gaze preference

GLOSSARY OF FREQUENTLY USED TERMS IN STROKE

Alexia: Inability to read in the presence of normal vision.

Agnosia: Difficulty recognizing familiar objects through the senses; perception without meaning.

Agraphia: Loss of the ability to write.

Aphasia: *Expressive Aphasia:* loss of the ability to express one's thoughts in speech and/or writing. *Receptive Aphasia:* inability to comprehend spoken and/or written language. *Global Aphasia:* inability to comprehend and/or use language skills.

Apraxia: Impaired ability to perform learned, complex motor tasks in the absence of weakness, sensory impairment or aphasia.

Aprosody: Loss of the understanding or expression of the normal musicality, intonation and gesture involved in normal communication. This often results in misunderstanding of humour or sarcasm.

Ataxia: Poor coordination of muscular movements such as walking or reaching for objects.

Cognition: Thinking and processing information: perceiving, remembering, imagining, judging, reasoning, conceiving.

Contralateral: Pertaining to the side of the body opposite the reference point.

Dysarthria: Impaired articulation that may be caused by a motor deficit of the tongue or speech muscles.

Dysphagia: Impaired ability to swallow.

Hemiparesis: Muscular weakness affecting one half of the body.

Hemispatial: Loss or reduced attention directed toward the contralateral side.

Neglect May be minimal such that the person does not recognize double simultaneous stimuli (e.g. touching both arms at the same time; the patient is only aware of the examiner touching the right arm) or severe (the patient does not recognize their own left arm or leg).

Hemianopsia: Blindness in one half of the visual field. Differentiating left hemianopsia from left visual neglect can be difficult.

Paralysis: Neurologic muscular weakness to the extent of immobility.

Vertigo: A false sense of rotation or movement; often described as "the world is spinning around me" or "like being on a boat on the ocean".

CRANIAL NERVE FUNCTION AND TESTING

Nerve	Function	Testing
I Olfactory • hemispheric	• smell	• pinch 1 nostril and get patient to smell objects, test on both sides
II Optic • hemispheric	• visual acuity • visual fields • assess fundi	• ophthalmoscope • close 1 eye, look at nose and cheek • peripheral vision x 4
III Oculomotor • originates mid-brain, emerges pons	• eyeball, eyelid movement • proprioception	• follows finger in star pattern (nystagnus) • pupillary response
IV Trochlear • midbrain	• eyeball movement • proprioception	• assessed with III & VI
V Trigeminal • originates in 4th ventricle, emerges pons	• chewing, opening jaw • 3 branches, ophthalmic, maxillary, mandibular • sensory: pain, touch, temperature	• cotton wool or soft touch from finger to 3 areas on both sides of face (sensory) • bite down on tongue depressor-both sides (motor)
VI Abducens • pons	• lateral movements of the eyeball	• assessed with III & IV

Nerve	Function	Testing
VII Facial • pons	• taste (salivary glands) • facial expressions • proprioception	• smile • wrinkle forehead • puff out cheeks
VIII Acoustic • pons	• cochlea (hearing) • vestibular (balance) • orientation in space	• rub fingers next to ear • stand with feet together
IX Glossopharyngeal • medulla	• controls swallowing • controls secretion of saliva • gag reflex, cough • taste • muscles of speech	• assess swallowing • say "ah", watch for upward movement in the back of the throat-quality & volume of speech
X Vagus • medulla	• sensory: impulses received from throat, esophagus, heart, lung, stomach, small intestine • affects HR and BP	• gag reflex, assess both sides of throat
XI Spinal Accessory • medulla	• shoulder and neck strength	• ask pt to shrug shoulders (symmetry) • rotate head
XII Hypoglossal • medulla	• innervates tongue	• observe for symmetry when tongue is out

TYPES OF STROKE

Stroke or brain attack is a sudden problem affecting the blood vessels of the brain. There are several types of stroke, and each type has different causes.

Ischemic Stroke

The most common type of stroke, accounting for almost 80% of all strokes, is caused by a clot or other blockage within an artery leading to the brain. Two types: **1) embolic and 2) thrombotic stroke.**

An **embolic stroke** is also caused by a clot within an artery (emboli) that was formed somewhere other than in the brain itself. Often from the heart, these emboli will travel the bloodstream until they become lodged and cannot travel any further.

A **thrombotic stroke** occurs when diseased or damaged cerebral arteries become blocked by the formation of a blood clot within the brain. Referred to as *cerebral thrombosis* or *cerebral infarction*, this type of event is responsible for almost 50% of all strokes.

Large-vessel thrombosis is the term used when the blockage is in one of the brain's larger blood-supplying arteries such as the carotid or middle cerebral.

Small-vessel thrombosis involves one (or more) of the brain's smaller, yet deeper penetrating arteries. This latter type of stroke is also called a **Lacunar stroke**.

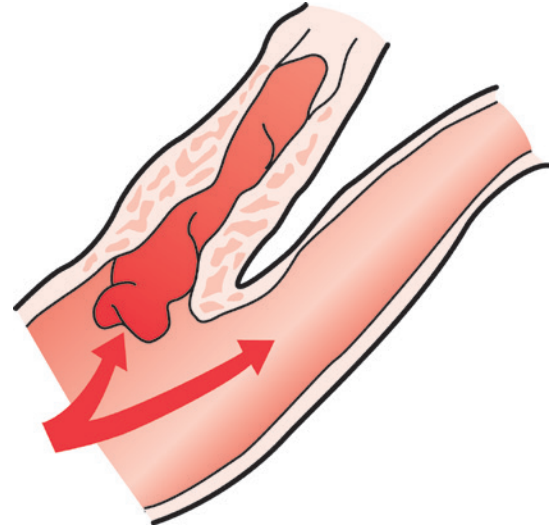

Hemorrhagic Stroke

Intracerebral hemorrhage occurs when a diseased blood vessel within the brain bursts, allowing blood to leak inside the brain. The sudden increase in pressure within the brain can cause damage to the brain cells surrounding the blood. Often occurs in selected parts of the brain, including the *basal ganglia*, *cerebellum*, *brainstem*, or *cortex*.

Subarachnoid hemorrhage occurs when a blood vessel just outside the brain ruptures. The area of the skull surrounding the brain (the subarachnoid space) rapidly fills with blood. A patient with subarachnoid hemorrhage may have a sudden, intense headache, neck pain, and nausea or vomiting.

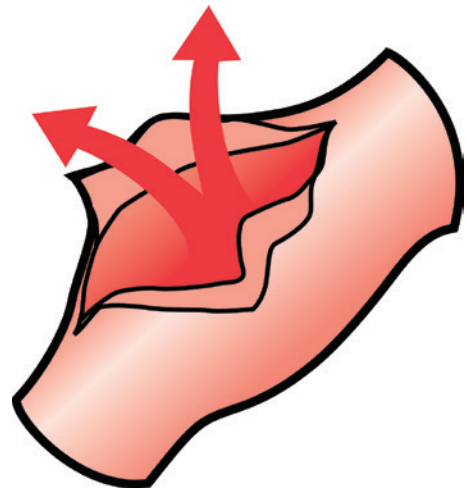

FUNCTIONS OF THE BRAIN AND THEIR RELATION TO STROKE

Structure/ Circulation	Key Functions	Associated Dysfunction
Frontal Lobe (emotions, motor, cognition, expressive language) <ul style="list-style-type: none"> • Anterior Cerebral Artery (ACA) • Middle Cerebral Artery (MCA) 	<ul style="list-style-type: none"> • Voluntary motor function • Memory for habits and motor activities • Controls expressive language, articulating speech (Broca's Area) • Assigns meaning to words we choose • Behavioural spontaneity • Controls emotional responses • Executive Functions: task initiation, motivation, planning and self-monitoring • Concentration/reasoning • Judgment/problem solving • Bladder control (micturation center) 	<ul style="list-style-type: none"> • Paralysis/paresis: of the face, arm and leg (MCA) or leg and foot (ACA) • Inability to express language (Broca's Aphasia) • Emotional lability, mood changes • Impulsivity of thought, affect and action • Lack of spontaneity in interacting with others • Inability to attend to task • Inability to plan a sequence of complex tasks, i.e. making coffee • Impaired judgment, problem-solving • Change in personality, sexual and social behaviour • Incontinence
Parietal Lobe (Sensation and Perception, Integration of Sensory Input)	<ul style="list-style-type: none"> • Visual attention • Touch perception • Goal directed voluntary movements • Manipulation of objects • Integration of different sensory input 	<ul style="list-style-type: none"> • Difficulty focusing visual attention or attending to more than one object at a time • Loss of sensation • Difficulty with hand/eye coordination; distinguishing left and right
<ul style="list-style-type: none"> • Anterior Cerebral Artery • Middle Cerebral Artery • Posterior Cerebral Artery 	<ul style="list-style-type: none"> • The ability to sense the position, location, orientation and movement of the body and its parts (Proprioception) 	<ul style="list-style-type: none"> • Inability to perceive objects normally (Agnosia) • Neglecting part of the body or space (contralateral neglect/ difficulties with ADLs) • Difficulty reading, writing (Agraphia), drawing, constructing, naming objects, calculating • Denial of deficits (Anosagnosia)
Temporal Lobe (Auditory Sensation and Perception, Memory, Language Comprehension, Affect)	<ul style="list-style-type: none"> • Hearing ability • Receptive language (Wernicke's Area) • Integration of visual, auditory, somatic information • Memory (storage, retrieval of words, experiences) • Emotions 	<ul style="list-style-type: none"> • Impaired auditory sensation and perception • Difficulty recognizing faces • Difficulty selectively attending to auditory and visual input • Disturbed language comprehension, word recognition (Wernicke's Aphasia) • Difficulty organizing verbal information • Short-term memory loss • Disturbance of long-term memory • Altered personality, emotional behaviour, sexual behaviour • Impulsiveness, aggressiveness, indifference, depression • Persistent talking
Occipital Lobe (Vision)	<ul style="list-style-type: none"> • Vision • Spatial organization and interpretation of visual information • Visual reflexes 	<ul style="list-style-type: none"> • Defects in vision: visual field cuts, diplopia (Hemianopia) • Inability to recognize familiar objects, words, colours, or movement of an object (Agnosias) • Difficulty with reading and writing

FUNCTIONS OF THE BRAIN AND THEIR RELATION TO STROKE (CON'D)

Structure/ Circulation	Key Functions	Associated Dysfunction
<p>Brainstem (Body Functions and Movements) (Midbrain, Pons, Medulla)</p> <ul style="list-style-type: none"> • Basilar Artery • Vertebral Artery • Houses Cranial Nerves III-XII 	<ol style="list-style-type: none"> 1) Receives information from cranial structures and controls muscles of the head (Cranial Nerves) 2) Contains neural circuits that transmit information from the spinal cord up to brain structures and from brain down to spinal cord 3) Brainstem structures work together to regulate arousal (reticular activating system) 4) Individually they subserve specific sensory and motor functions 	<p>Midbrain (Visual/auditory reflexes)</p> <ul style="list-style-type: none"> • Unable to move eye up, down or in • Inappropriate responses to visual or auditory stimuli <p>Pons (Blood pressure and respiratory regulation)</p> <ul style="list-style-type: none"> • Altered respiratory function • Impaired chewing and facial sensation • Unable to move the eye out • Altered taste • Abnormal facial expression • Problems with equilibrium and hearing <p>Medulla (Blood pressure and respiratory regulation)</p> <ul style="list-style-type: none"> • Altered respiratory, cardiac and blood pressure function • Altered sensation and limb weakness • Difficulty maintaining posture control • Swallowing problems • Unable to move head and shoulder, tongue • Altered salivation
<p>Diencephalon (Thalamus, Hypothalamus)</p> <ul style="list-style-type: none"> • Posterior Cerebral Artery 	<p>Thalamus</p> <ul style="list-style-type: none"> • Transmits information to cerebral hemispheres for sensation and movement <p>Hypothalamus</p> <ul style="list-style-type: none"> • Integrates the function of the autonomic nervous system (maintains blood pressure, heart rate, respiratory rate, temperature, fluid balance, hormone synthesis, sleep-wakefulness) 	<p>Contralateral weakness</p> <ul style="list-style-type: none"> • Contralateral sensory loss • Vertical and lateral gaze deficits • Hypersensitivity response to stimulus <ul style="list-style-type: none"> • Alteration in temperature regulation • Diabetes insipidus • Abnormal heart and respiratory patterns • Impaired blood sugar levels
<p>Cerebellum (Motor Control)</p> <ul style="list-style-type: none"> • Posterior Cerebral Artery • Basilar Artery • Vertebral Artery 	<ul style="list-style-type: none"> • Regulates movements of eyes and limbs; helps maintain posture and balance • Coordinates voluntary movement, muscle tone, balance and equilibrium • Control of fine motor movements 	<ul style="list-style-type: none"> • Limb and gait ataxia; impaired ability to walk • Difficulty judging distance, when to stop • Difficulty performing rapid alternating movements • Vertigo • Tremors • Loss of balance and coordination • Poor coordination of fine motor movements, weak muscles
<p>Basal Ganglia</p> <ul style="list-style-type: none"> • Middle Cerebral Artery 	<ul style="list-style-type: none"> • Production of dopamine and coordination of muscle movement and posture 	<ul style="list-style-type: none"> • Loss of postural control • Tremor, rigidity, involuntary movements

CANADIAN NEUROLOGICAL SCALE

©Robert Côté. Used with permission.

Assess: Vital Signs and Pupils

Vital Signs: BP, Temp, Pulse, Respirations, Oximetry

Pupils: Size and reaction to light

Section A: MENTATION: LOC, Orientation, Speech

LEVEL OF CONSCIOUSNESS:

CNS (Alert, Drowsy) GCS (Stuporous, Comatose)

ORIENTATION:

Place (city or hospital), Time (month and year)

*Patient can speak, write, or gesture their responses.

SCORE: Patient is Oriented, score 1.0, if they correctly state both place and correct month and year. If dysarthric, speech must be intelligible. If patient cannot state both, Disoriented, score 0.0

SPEECH:

RECEPTIVE: Ask patient the following separately (do not prompt by gesturing):

1. Close your eyes
2. "Does a stone sink in water?"
3. Point to the ceiling

SCORE: If patient is unable to do all three, Receptive Deficit, score 0.0, go to A2.

EXPRESSIVE:

1. Show patient 3 items separately (pencil, watch, key) and ask patient to name each object.
2. Ask patient what each object is used for while holding each up again, i.e. "What do you do with a pencil?"

SCORE: If patient is able to state the name and use of all 3 objects, Normal Speech, score 1.0.

If patient is unable to state the name and use of all 3 objects, Expressive Deficit, score 0.5.

*If patient answers all questions correctly but speech is slurred and intelligible, score Normal Speech and record "SL" along with the score.

Section A1: MOTOR FUNCTION

NO RECEPTIVE DEFICIT

FACE: Ask patient to smile/grin, note weakness in mouth or nasal/labial folds.

SCORE: None/no weakness = 0.5 or Present/weakness = 0.0 Test both limbs and always record the side with the WORST deficit and indicate side by entering a R/L.

None 1.5	no weakness present
Mild 1.0	mild weakness present, full ROM, cannot withstand resistance
Significant 0.5	moderate weakness, some movement, not full ROM
Total 0.0	complete loss of movement; total weakness

SCORE:

Arm: Proximal Ask patient to lift arm 45-90 degrees. Apply resistance between shoulder and elbow.

Arm: Distal Ask patient to make fist and flex wrist backwards, apply resistance between wrist and knuckles.

Leg: Proximal In supine, ask patient to flex hip to 90 degrees, apply pressure to mid thigh.

Leg: Distal Ask patient to dorsiflex foot, apply resistance to top of foot.

Section A2: MOTOR RESPONSE

RECEPTIVE DEFICIT PRESENT

FACE: Have patient mimic your smile. If unable, note facial expression while applying sternal pressure.

SCORE: Symmetrical 0.5 Asymmetrical 0.0

ARMS: Demonstrate or lift patient's arms to 90 degrees, score ability to maintain equal levels (>5 secs).

If unable to maintain raised arms, apply nail bed pressure to assess reflex response.

SCORE: Score: Equal 1.5 Unequal 0.0

LEGS: Lift patient's hip to 90 degrees, score ability to maintain equal levels (>5 secs). If unable to maintain raised position, apply nail bed pressure to assess reflex response.

SCORE: Equal 1.5 Unequal 0.0

NIH STROKE SCALE (NIHSS)

1a. Level of Consciousness (LOC)*

- 0 = Alert (keenly responsive)
- 1 = Not alert but arousable by minor stimulation
- 2 = Not alert: requires repeated stimulation to attend, or is obtunded and requires strong or painful stimulation to make movements
- 3 = Responds only with reflex motor or autonomic effects or totally unresponsive, flaccid, and flexic

*The investigator should choose a response even in patients with endotracheal tubes, language barrier, orotracheal trauma/bandages, etc. A score of 3 is only given if the patient fails to respond (other than reflexive posturing) after noxious stimulation.

1b. LOC Questions*

Ask the patient: "What month is it? How old are you?"

- 0 = Answers both correctly
- 1 = Answers one correctly
- 2 = Answers neither correctly

*Score only the initial answer (there is no credit for being close). Patients unable to speak due to intubation, orotracheal trauma, severe dysarthria, language barrier, etc., are scored 1. Aphasic and stuporous patients are scored 2.

1c. LOC Commands*

Command the patient to: "Open and close your eyes. Grip and release your hand."

- 0 = Performs both correctly
- 1 = Performs one correctly
- 2 = Performs neither correctly

*Make sure the patient is asked to use the unaffected nonparetic hand. Substitute another command if the hands cannot be used. Score only the first attempt. Patients too weak to complete the command can be scored if they've made an unequivocal attempt to follow the command. If the patient is unresponsive, the task should be demonstrated.

2. Best Gaze*

Establish eye contact and ask the patient to: "Follow my finger."

- 0 = Normal
- 1 = Partial gaze palsy
- 2 = Forced deviation or total gaze paresis

*Appropriate for aphasic patients. Forced deviation or total gaze paresis is not overcome by oculoccephalic maneuver. Score voluntary or reflexive, horizontal eye movements (do not do caloric test). Test patients with ocular trauma, bandages, preexisting blindness, etc., for reflexive movement and a choice is made by the investigator. Patients with conjugate deviation of the eyes (overcome by voluntary or reflexive activity) and those with isolated peripheral nerve paresis (CN III, IV or VI) are scored 1.

3. Visual Fields*

Use confrontation, finger counting, or visual threat. Confront upper/lower quadrants of visual field.

- 0 = No visual loss
- 1 = Partial hemianopsia
- 2 = Complete hemianopsia
- 3 = Bilateral hemianopsia

*Test patients with unilateral blindness or enucleation in remaining eye. Patients with clear-cut asymmetry, including quadrantanopia, are scored 1. Blind patients are scored 3. Test again using double simultaneous stimulation. Score 1 for extinction and record under item 11.

4. Facial Palsy*

By words or pantomime, encourage the patient to: "Show me your teeth. Raise your eyebrows. Close your eyes."

- 0 = Normal symmetrical movement
- 1 = Minor paralysis (flattened nasolabial fold, asymmetry on smiling)
- 2 = Partial paralysis (lower face)
- 3 = Complete paralysis

*If possible, remove facial bandages, orotracheal tube, tape, etc., before testing. In poorly responsive patients, score symmetry of grimace in response to noxious stimuli.

Healthcare professionals using the NIH Stroke Scale as a diagnostic tool on patients must show and document proper competency on the use of the tool. Before using this pocket guide, make sure that you are following the standards for training and certification program, which is located at www.NIHStrokeScale.org and distributed FREE of charge to healthcare professionals by www.HealthCarePoint.com. If you have any additional questions please email strokebestpractices@hsf.ca.

NIH STROKE SCALE (NIHSS) CONT'D

5. Arm Motor*

Alternately position patient's arms. Extend each arm with palms down (90° if sitting, 45° if supine).

- 0 = No drift 1 = Drift
- 2 = Some effort vs gravity
- 3 = No effort vs gravity
- 4 = No movement
- UN = Amputation or joint fusion

*Test each arm in turn (nonparetic arm first). Drift is scored if arm falls before 10 seconds. Score untestable (UN) only for patients with amputations or joint fusions of shoulder.

6. Leg Motor*

Alternately position patient's legs.

Extend each leg (30°, always while supine).

- 0 = No drift 1 = Drift
- 2 = Some effort vs gravity
- 3 = No effort vs gravity
- 4 = No movement
- UN = Amputation or joint fusion

*Test each leg in turn (nonparetic leg first). Drift is scored if leg falls before 5 seconds. Score UN only for patients with amputations or joint fusions of hip.

7. Limb Ataxia*

Ask patient (eyes open) to: "Touch your finger to your nose. Touch your heel to your shin."

- 0 = Absent
- 1 = Present in one limb
- 2 = Present in two or more limbs
- UN = Amputation or joint fusion

*Perform finger-nose and heel-shin tests on both sides to determine unilateral cerebellar lesion. Score 0 for patients who are paralyzed or cannot understand. Score 1 or 2 only if ataxia is disproportionate to weakness. Score UN only for patients with amputations or joint fusions.

8. Sensory*

Test as many body parts as possible (arms [not hands], legs, trunk, face) for sensation using pinprick or noxious stimulus (in the obtunded or aphasic patient).

- 0 = Normal
- 1 = Mild-to-moderate sensory loss
- 2 = Severe-to-total sensory loss

*Score sensory loss due to stroke only. Stuporous and aphasic patients are scored 0 or 1. Patients with brainstem stroke and bilateral sensory loss, quadriplegic patients who do not respond, and comatose patients (item 1a = 3) are scored 2. A score of 2 is only given when severe or total sensory loss is demonstrated.

9. Best Language*

Using pictures and a sentence list (see reverse), ask the patient to: "Describe what you see in this picture. Name the items in this picture. Read these sentences."

- 0 = No aphasia
- 1 = Mild-to-moderate aphasia
- 2 = Severe aphasia
- 3 = Mute, global aphasia

*Patients with visual loss can be asked to identify and describe objects placed in the hand. Intubated patients should be asked to write their answers. The examiner must choose a score for stuporous or uncooperative patients. Comatose patients (item 1a = 3) are scored 3. A score of 3 is only given if the patient is mute and unable to follow one-step commands.

10. Dysarthria*

Using a simple word list (see reverse), ask the patient to: "Read these words" or "Repeat these words".

- 0 = Normal articulation
- 1 = Mild-to-moderate dysarthria
- 2 = Severe dysarthria
- UN = Intubated or other physical barrier

*Patients with severe aphasia can be scored based on the clarity of articulation of their spontaneous speech. Score UN only for patients who are intubated or have other physical barriers to speech. Do not tell patients why they are being tested.

11. Extinction and Inattention*

Sufficient information to determine these scores may have been obtained during the prior testing.

- 0 = No abnormality
- 1 = Visual, tactile, auditory, spatial, or personal inattention
- 2 = Profound hemi-inattention or extinction to more than one modality

*Lack of patient response and inattention may already be evident from the previous items. Score 0 if the patient has a severe visual loss preventing visual double simultaneous stimulation, but the response to cutaneous stimuli is normal, or if the patient has aphasia but does not appear to attend to both sides. The presence of visual spatial attention or anosognosia may also be evidence of abnormality.

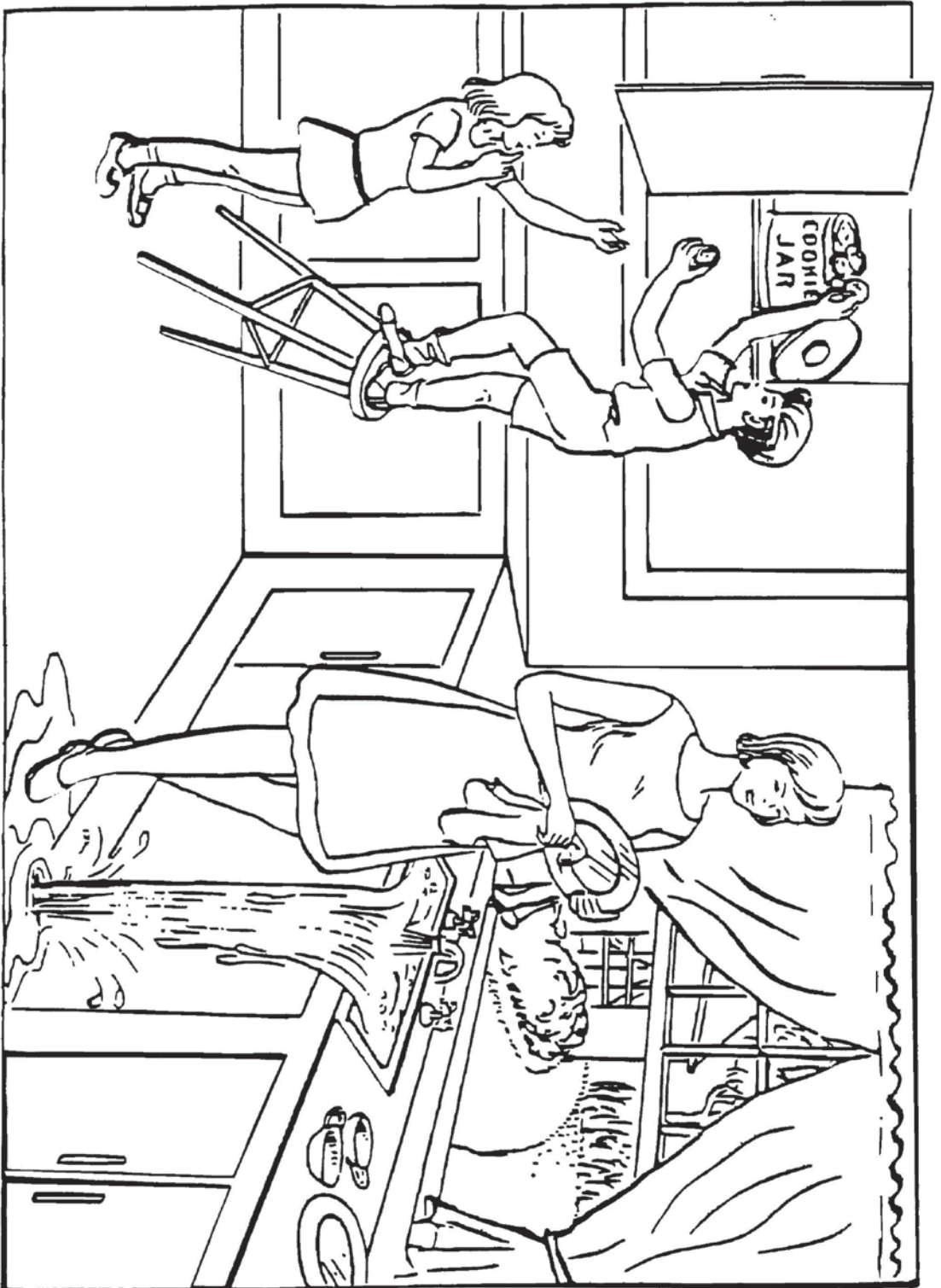

0437E07

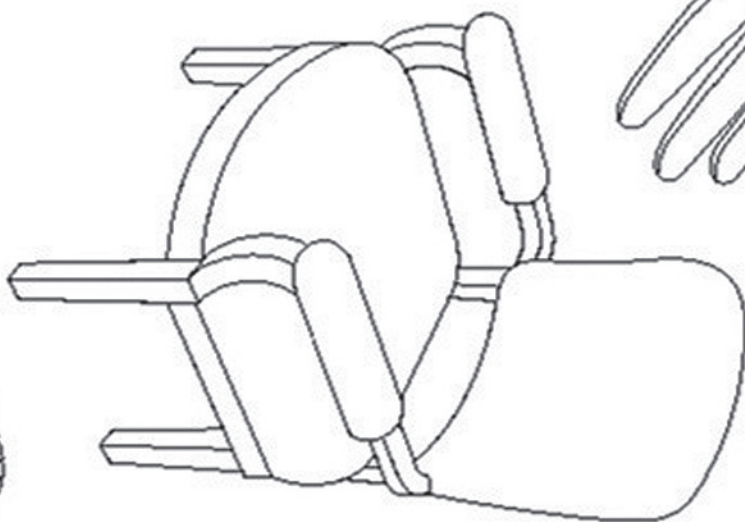
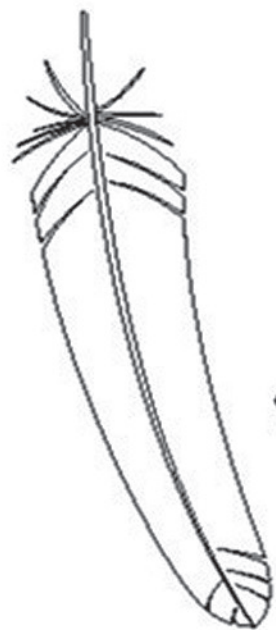
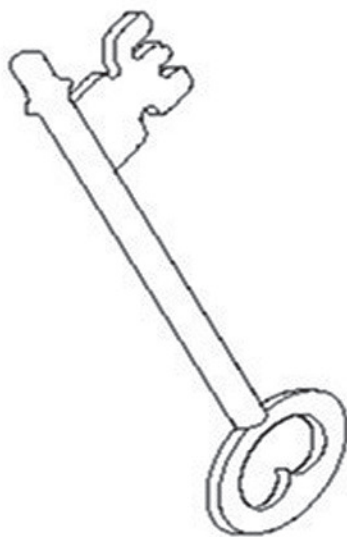
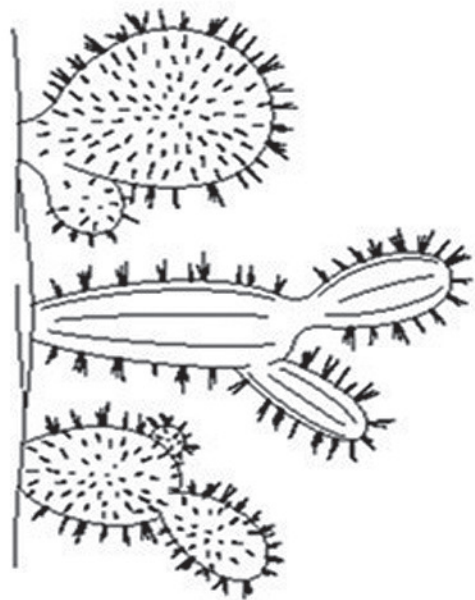
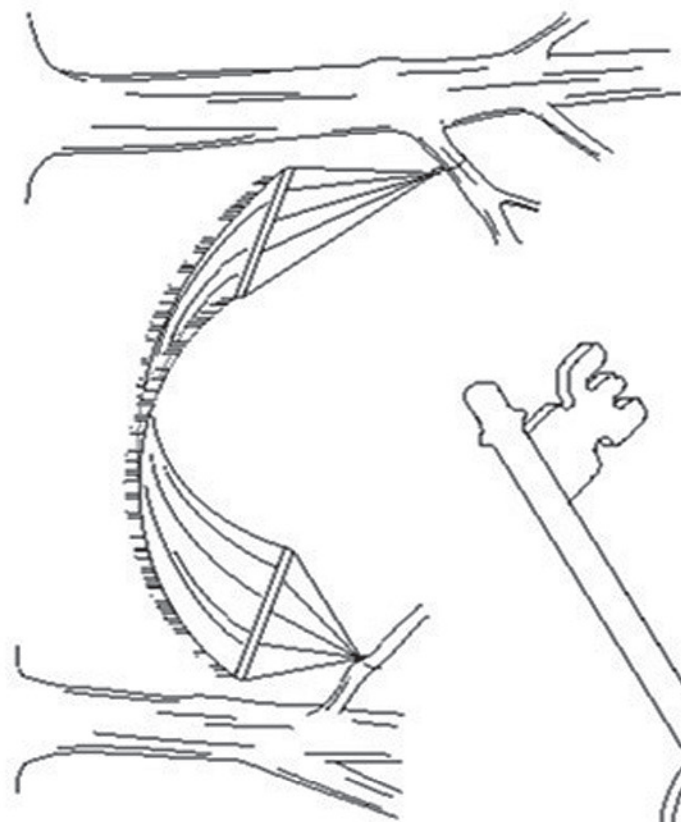

You know how.

Down to earth.

I got home from work.

Near the table in the dining room.

They heard him speak on the radio last night.

MAMA

TIP-TOP

FIFTY-FIFTY

THANKS

HUCKLEBERRY

BASEBALL PLAYER

RECURRENT STROKE RISK ASSESSMENT & PREVENTION GUIDE

Patients Presenting with Transient Ischemic Attack or Non-Disabling Stroke

Triage patient based on time since onset of stroke symptoms and clinical presentation.

HIGHEST RISK (MOST URGENT)	HIGHER RISK
SYMPTOM ONSET – WITHIN 48 HOURS	
<p>SYMPTOMS: Transient, fluctuating or persistent unilateral motor weakness (face, arm and/or leg), or speech disturbance.</p>	<p>SYMPTOMS: Transient, fluctuating or persistent symptoms such as hemibody sensory loss, acute monocular visual loss, binocular diplopia, hemivisual loss, or dysmetria; without motor weakness or speech disturbance.</p>
<p>IMMEDIATE ACTIONS:</p> <ol style="list-style-type: none">Immediate transport via EMS to the closest emergency department with capacity for advanced stroke care (brain imaging, tPA capability).Initial Investigations:<ol style="list-style-type: none">Urgent brain imaging (CT or MRI) and non-invasive vascular imaging, including intracranial and extracranial vessels where possible.12 lead ECG to assess for atrial fibrillation.Initiate antiplatelet therapy if no blood on CT scan.	<p>IMMEDIATE ACTIONS:</p> <ol style="list-style-type: none">Refer for same-day assessment at the closest stroke prevention clinic or emergency department with capacity for advanced stroke care (brain imaging, possibly tPA capacity).Initial Investigations:<ol style="list-style-type: none">Same-day brain imaging (CT or MRI) and non-invasive vascular imaging.12 lead ECG to assess for atrial fibrillation.Initiate antiplatelet therapy if no blood on CT scan.

ADDITIONAL CLINICAL INVESTIGATIONS

- Brain imaging (CT or MRI) and non-invasive vascular imaging of the intracranial and extracranial vasculature using CT angiography at the time of brain CT, or alternatively carotid ultrasound or MR angiography if CTA not available.
- Laboratory investigations: hematology (complete blood count), electrolytes, coagulation (aPTT, INR), renal function (creatinine, e-glomerular filtration rate), fasting lipid profile, fasting glucose level and A1C, and ALT.
- ECG to assess baseline cardiac rhythm and presence of structural heart disease.
- Prolonged ECG monitoring (Holter monitoring, loop recorder, event monitoring as available) where a cardioembolic mechanism is possible and/or the stroke mechanism has not been identified.

Please refer to the Hyperacute Module and the Prevention of Stroke Module for specific management recommendations based on results of the investigations above. strokebestpractices.ca

RECURRENT STROKE RISK ASSESSMENT & PREVENTION GUIDE CONT'D

Patients Presenting with Transient Ischemic Attack or Non-Disabling Stroke

Triage patient based on time since onset of stroke symptoms and clinical presentation.

INCREASED RISK		LOWER RISK
SYMPTOM ONSET - WITHIN 48 HOURS TO 2 WEEKS		
<p>SYMPTOMS: Transient, fluctuating or persistent unilateral motor weakness (face, arm and/or leg), or speech disturbance.</p>	<p>SYMPTOMS: Transient, fluctuating or persistent symptoms such as hemibody sensory loss, acute monocular visual loss, binocular diplopia, hemivisual loss, or dysmetria; without motor weakness or speech disturbance.</p>	<p>SYMPTOMS: Patient who presents more than 2 weeks from symptom onset. Patient experiencing atypical sensory symptoms which do not fit an anatomical distribution to suggest stroke or TIA (such as patchy numbness and/or tingling).</p>
<p>IMMEDIATE ACTIONS:</p> <ol style="list-style-type: none"> Within 24 hours of first contact with healthcare system: comprehensive clinical evaluation and investigations, including brain and vascular imaging, by a healthcare professional with stroke expertise. Initiate antiplatelet therapy if no blood on CT scan. 	<p>IMMEDIATE ACTIONS:</p> <ol style="list-style-type: none"> Within 2 weeks of first contact with the healthcare system: comprehensive clinical evaluation and investigations, including brain and vascular imaging, by a healthcare professional stroke expertise. Initiate antiplatelet therapy if no blood on CT scan. 	<p>IMMEDIATE ACTIONS:</p> <ol style="list-style-type: none"> Within 1 month of first contact with the healthcare system: should be seen by a healthcare professional with expertise in neurology or stroke for evaluation as soon as possible.

ADDITIONAL CLINICAL INVESTIGATIONS

- Brain imaging (CT or MRI) and non-invasive vascular imaging of the intracranial and extracranial vasculature using CT angiography at the time of brain CT, or alternatively carotid ultrasound or MR angiography if CTA not available.
- Laboratory investigations: hematology (complete blood count), electrolytes, coagulation (aPTT, INR), renal function (creatinine, e-glomerular filtration rate), fasting lipid profile, fasting glucose level and A1C, and ALT.
- ECG to assess baseline cardiac rhythm and presence of structural heart disease.
- Prolonged ECG monitoring (Holter monitoring, loop recorder, event monitoring as available) where a cardioembolic mechanism is possible and/or the stroke mechanism has not been identified.

Please refer to the Hyperacute Module and the Prevention of Stroke Module for specific management recommendations based on results of the investigations above. strokebestpractices.ca

PART TWO: DEVELOP AN INDIVIDUALIZED MANAGEMENT PLAN

>> Immediate Secondary Prevention Strategies

☐ Antithrombotic Therapy in Ischemic Stroke and TIA

- Start antiplatelet therapy immediately after ruling out intracranial hemorrhage with one of:
 - ECASA 160 – 325mg load, followed by dose 81mg daily; or
 - Clopidogrel 300mg load, followed by 75mg daily; or
 - ECASA 160 – 325mg load followed by one capsule twice daily of ASA 25mg/extended-release dipyridamole 200mg.
- Short-term concurrent use of acetylsalicylic acid 81 mg and clopidogrel 75 mg daily (up to 90 days) has not shown an increased risk of bleeding; however, longer-term use is not recommended for secondary stroke prevention, unless there is an alternate indication.

☐ Antithrombotic for Atrial Fibrillation for Individuals with Stroke

- Patients with TIA or ischemic stroke (CHADS \geq 2) and atrial fibrillation should receive oral anticoagulation.
- In most patients, direct oral anticoagulants (DOAC) such as apixaban, dabigatran, rivaroxiban or edoxaban (pending approval in Canada) should be prescribed in preference to warfarin.
- Renal function should be routinely monitored and measured at least annually, or following a change in the patient's health status.
- For patients on warfarin, therapeutic goal is INR between 2.0 and 3.0 (aim for an INR of 2.5).
- Patient specific criteria should be considered when selecting a DOAC (e.g., age, renal function, GI bleeding, concomitant VTE).
- Most physicians will use ASA until the patient is anticoagulated.

- Bridging with heparin is not recommended.
- Concomitant use of anticoagulants and antiplatelets should be avoided unless deemed medically necessary (e.g. CAD, stents etc.).

☐ Carotid Artery Evaluation

- Refer patients with transient ischemic attack or non-disabling stroke and ipsilateral 50 to 99 percent internal carotid artery stenosis to an individual with neurovascular expertise.
- Individuals with mild stroke or transient ischemic attack should be offered carotid endarterectomy *without delay within* fourteen days after stroke onset.

Canadian Stroke Best Practice Recommendations: Prevention of Stroke Guidelines, Update 2014, Heart and Stroke Foundation of Canada, *International Journal of Stroke*, 2015; Volume 10 (Issue 3):pp 282-291, Copyright © 2014, World Stroke Organization, John Wiley & Sons Ltd.

>> Long-Term Secondary Prevention Strategies for Aggressive Risk Factor Management

☐ Aggressive Risk Factor Modification

- Assess and TREAT all vascular risk factors, additional patient-specific risk factors and sub-optimal lifestyle practices, including:
 - Diet, sodium intake, exercise, weight, and alcohol intake.
 - Provide referrals and links to appropriate community-based lifestyle modification programs and supportive services.

Blood Pressure Management

- Monitor blood pressure at all healthcare encounters.
- Aim for gradual blood pressure reduction over several visits to achieve post stroke or TIA targets of consistently lower than 140/90mmHg.
- For patients with diabetes target blood pressure to consistently lower than 130/80mmHg.
- For recommendations on specific agents and sequence of agents for the secondary prevention of stroke, refer to the current Canadian Hypertension Education Program guidelines at <https://hypertension.ca/en/chep>

Lipid Management

- Prescribe statins for patients with TIA or ischemic stroke to a target LDL of <2.0 mmol/l, or a 50% reduction in LDL cholesterol from baseline.
- When drug therapy is needed, initiate statin therapy with intensive lipid-lowering effects unless there are contraindications.

Diabetes Management

- Therapy must be individualized and aimed at glycemic control.
- Target therapy to achieve a glycated hemoglobin (A1C) level of $\leq 7.0\%$; fasting plasma glucose (FPG) target of 4.0 to 7.0 mmol/L.

Smoking Cessation

- Determine smoking status.
- Discuss smoking cessation readiness and options.
- Make appropriate referrals to support smoking cessation efforts.

Management of Depression, Anxiety and Cognitive Changes

- Patients and family members (especially primary caregivers) should be screened for mood changes and changes in cognition (executive function, IADLs, memory).
- Screening for mood and cognition changes should occur periodically, as changes may manifest over a longer period of time.
- Make appropriate referrals for comprehensive assessment and ongoing management of mood and cognitive changes.
- Continue to provide patient and family education at all healthcare encounters.

Sleep Apnea

- Sleep apnea screening should be considered in patients with stroke, especially in presence of drug resistant hypertension and/or atrial fibrillation. Refer patients with suspected sleep apnea to a sleep specialist for further assessment and management.

Functional Assessment and Management

- Anticipate the possibility of post-stroke fatigue, and prepare patients and families to mitigate fatigue through assessment, education, and interventions at any point during the stroke-recovery continuum.
- Selected patients with clinical evidence of ischemic stroke should be assessed for functional impairment when appropriate (e.g., cognitive evaluation, screening for depression, screening of fitness to drive, and functional assessments for potential rehabilitation needs).
- Make appropriate referrals for out-patient, ambulatory or community-based rehabilitation and recovery programs.

LEARN THE SIGNS OF STROKE

FACE is it drooping?

A RMS can you raise both?

S PEECH is it slurred or jumbled?

T IME to call 9-1-1 right away.

ACT **F A S T** BECAUSE THE QUICKER YOU ACT,
THE MORE OF THE PERSON YOU SAVE.

© Heart and Stroke Foundation of Canada, 2014

To learn more about the Signs of Stroke
visit heartandstroke.ca/FAST

The information contained in this document supports the
Canadian Stroke Best Practice Recommendations

For detailed recommendations and updates visit:
strokebestpractices.ca



HEART &
STROKE[™]
FOUNDATION

CANADIAN
Stroke
BEST PRACTICE
RECOMMENDATIONS